



South Bay Foundry

9444 Abraham Way
42 North Cluff
895 S. Inland Center Dr.

Santee, CA 92071
Lodi, CA 95240
San Bernardino, CA

(619) 956-2780
(209) 367-1940
(909) 888-3334

SBF 1371 MANHOLE FRAME & COVER

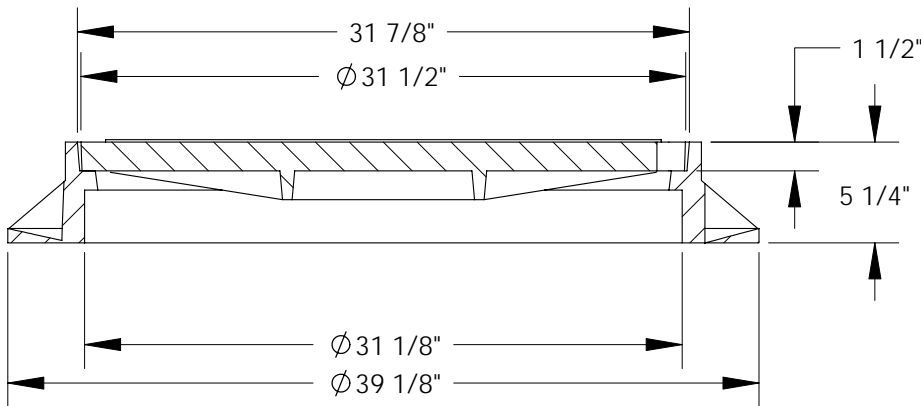

CLASS 35B

Set Weight	
Frame	219 Lbs
Cover	215 Lbs
Total	434 Lbs

General Information

- All materials used shall conform to ASTM A48, Class 35B, using wheel load test method to 48,700 lbs.
- Frame and cover bearing surfaces shall be machined to assure close, quiet fit.
- Castings shall conform to mag section 787 and detail No. 424.

Approved	
By:	
Title:	
Agency:	
Date:	
Comments	